

# P6KE SERIES

## TRANSIENT VOLTAGE SUPPRESSOR DIODES

**Voltage Range**  
**6.8 to 400 Volts**  
**600 Watts Peak Power**  
**2.0 Watts Steady State**

### DO-15

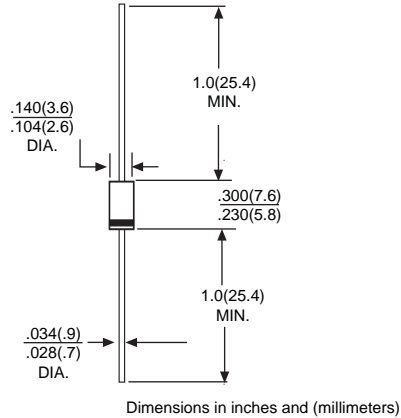

#### Features

- \*Plastic package has Underwriters Laboratory Flammability Classification 94V-0
- \*Exceeds environmental standards of MIL-STD-19500
- \*600W surge capability at 10 x 100us waveform, duty cycle: 0.01%
- \*Excellent clamping capability
- \*Low zener impedance
- \*Fast response time: Typically less than 1.0ps from 0 volts to VBR for unidirectional and 5.0 ns for bidirectional
- \*Typical IR less than 1uA above 10V
- \*High temperature soldering guaranteed: 250°C / 10 seconds / .375" (9.5mm) lead length / 5lbs. (2.3kg) tension

#### Mechanical Data

- \*Cases: Molded plastic
- \*Lead: Axial leads, solderable per MIL-STD-202, Method 208
- \*Polarity: Color band denotes cathode except bipolar
- \*Weight: 0.34 gram

## MAXIMUM RATINGS AND ELECTRICAL CHARACTERISTICS

Rating at 25°C ambient temperature unless otherwise specified.  
 Single phase, half wave, 60Hz, resistive or inductive load.  
 For capacitive load, derate current by 20%

Type Number		Value	Units
Peak Power Dissipation at $T_A=25^\circ\text{C}$ , $T_p=1\text{ms}$ (Note 1)	PPK	Minimum 600	Watts
Steady State Power Dissipation at $T_L=25^\circ\text{C}$ Lead Lengths .375", 9.5mm (Note 2)	P <sub>D</sub>	2.0	Watts
Peak Forward Surge Current, 8.3 ms Single Half Sine-wave Superimposed on Rated Load (JEDEC method)(Note 3)	I <sub>FSM</sub>	100	Amps
Maximum Instantaneous Forward Voltage at 50.0A for Unidirectional Only (Note 4)	V <sub>F</sub>	3.5/5.0	Volts
Operating and Storage Temperature Range	T <sub>J</sub> , T <sub>STG</sub>	-55 to +175	°C

- NOTES: 1. Non-repetitive Current Pulse Per Fig.3 and Derated above  $T_A=25^\circ\text{C}$  Per Fig.2.  
 2. Mounted on Copper Pad Area of 1.6 x 1.6" (40 x 40 mm) Per Fig.4  
 3. 8.3ms Single Half Sine-Wave or Equivalent Square Wave, Duty Cycle=4 Pulses Per Minutes Maximum.  
 4.  $V_F=3.5\text{V}$  for Devices of  $V_{BR}\leq 200\text{V}$  and  $V_F=5.0\text{V}$  Max. for Devices  $V_{BR}>200\text{V}$ .  
 Devices for Bipolar Applications  
 1. For Bidirectional Use C or CA Suffix for Types P4KE6.8 through Types P6KE400.  
 2. Electrical Characteristics Apply in Both Directions.

# RATING AND CHARACTERISTIC CURVES P6KE SERIES

FIG.1- PEAK PULSE POWER RATING CURVE

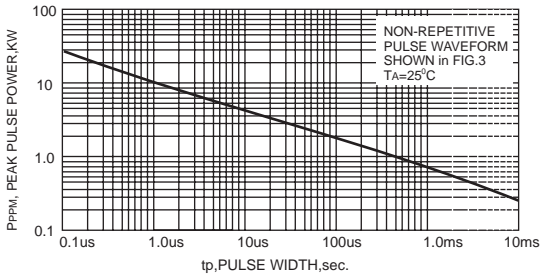

FIG.2-PULSE DERATING CURVE

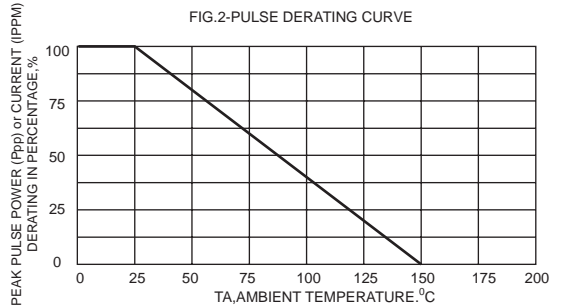

FIG.3- PULSE WAVEFORM

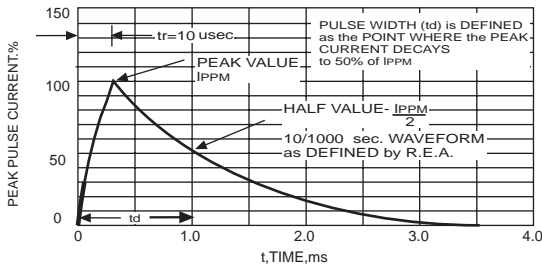

FIG.4-STEADY STATE POWER DERATING CURVE

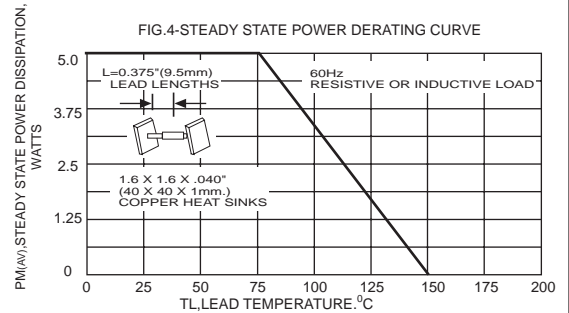

FIG.5-MAXIMUM NON-REPETITIVE FORWARD SURGE CURRENT UNIDIRECTIONAL ONLY

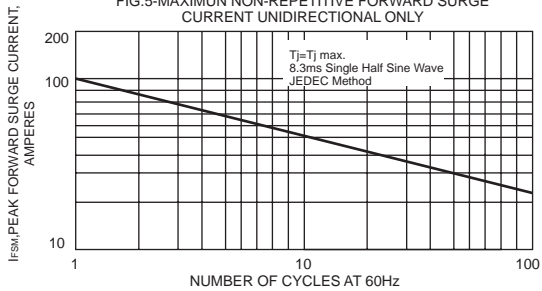

FIG.6-TYPICAL REVERSE LEAKAGE CHARACTERISTICS

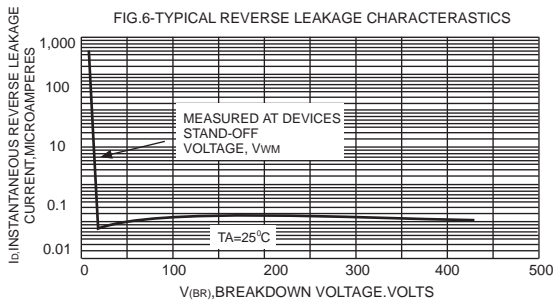
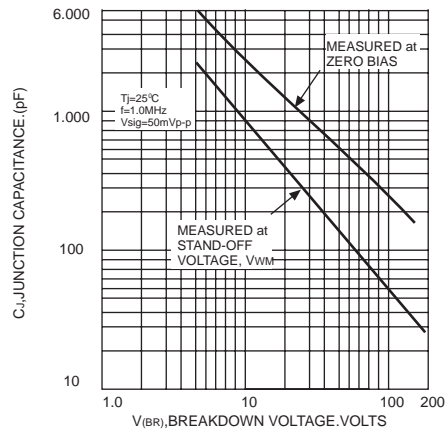

FIG.7-TYPICAL JUNCTION CAPACITANCE UNIDIRECTIONAL



# ELECTRICAL CHARACTERISTICS (TA=25°C unless otherwise noted)

Device	Nominal Voltage (Volts)	Breakdown Voltage		Test Current @IT (mA)	Stand-off voltage VWM (Volts)	Maximum Reverse Leakage at VWM ID(uA)	Maximum Peak Pulse Current IPPM (Note 2)(Amps)	Maximum Clamping Voltage at IPPM Vc(Volts)	Maximum Temperature Coefficient of VBR(%/°C)
		VBR							
		(Volts) (Note 1)							
Min	Max								
P6KE6.8	6.8	6.12	7.48	10	5.50	1000	58	10.8	0.057
P6KE6.8A	6.8	6.46	7.14	10	5.80	1000	60	10.5	0.057
P6KE7.5	7.5	6.75	8.25	10	6.05	500	53	11.7	0.061
P6KE7.5A	7.5	7.13	7.88	10	6.40	500	55	11.3	0.061
P6KE8.2	8.2	7.38	9.02	10	6.63	200	50	12.5	0.065
P6KE8.2A	8.2	7.79	8.61	10	7.02	200	52	12.1	0.065
P6KE9.1	9.1	8.19	10.0	1.0	7.37	50	45	13.8	0.068
P6KE9.1A	9.1	8.65	9.55	1.0	7.78	50	47	13.4	0.068
P6KE10	10	9.00	11.0	1.0	8.10	10	42	15.0	0.073
P6KE10A	10	9.50	10.5	1.0	8.55	10	43	14.5	0.073
P6KE11	11	9.90	12.1	1.0	8.92	5.0	38	16.2	0.075
P6KE11A	11	10.5	11.6	1.0	9.40	5.0	40	15.6	0.075
P6KE12	12	10.8	13.2	1.0	9.72	5.0	36	17.3	0.078
P6KE12A	12	11.4	12.6	1.0	10.2	5.0	37	16.7	0.078
P6KE13	13	11.7	14.3	1.0	10.5	5.0	33	19.0	0.081
P6KE13A	13	12.4	13.7	1.0	11.1	5.0	34	18.2	0.081
P6KE15	15	13.5	16.5	1.0	12.1	5.0	28	22.0	0.084
P6KE15A	15	14.3	15.8	1.0	12.8	5.0	29	21.2	0.084
P6KE16	16	14.4	17.6	1.0	12.9	5.0	26	23.5	0.086
P6KE16A	16	15.2	16.8	1.0	13.6	5.0	28	22.5	0.086
P6KE18	18	16.2	19.8	1.0	14.5	5.0	23	26.5	0.088
P6KE18A	18	17.1	18.9	1.0	15.3	5.0	25	25.5	0.088
P6KE20	20	18.0	22.0	1.0	16.2	5.0	21	29.1	0.090
P6KE20A	20	19.0	21.0	1.0	17.1	5.0	22	27.7	0.090
P6KE22	22	19.8	24.2	1.0	17.8	5.0	19	31.9	0.092
P6KE22A	22	20.9	23.1	1.0	18.8	5.0	20	30.6	0.092
P6KE24	24	21.6	26.4	1.0	19.4	5.0	18	34.7	0.094
P6KE24A	24	22.8	25.2	1.0	20.5	5.0	19	33.2	0.094
P6KE27	27	24.3	29.7	1.0	21.8	5.0	16	39.1	0.096
P6KE27A	27	25.7	28.4	1.0	23.1	5.0	16.8	37.5	0.096
P6KE30	30	27.0	33.0	1.0	24.3	5.0	14	43.5	0.097
P6KE30A	30	28.5	31.5	1.0	25.6	5.0	15	41.4	0.097
P6KE33	33	29.7	36.3	1.0	26.8	5.0	13.0	47.7	0.098
P6KE33A	33	31.4	34.7	1.0	28.2	5.0	13.8	45.7	0.098
P6KE36	36	32.4	39.6	1.0	29.1	5.0	12	52.0	0.099
P6KE36A	36	34.2	37.8	1.0	30.8	5.0	12.6	49.9	0.099
P6KE39	39	35.1	42.9	1.0	31.6	5.0	11.1	56.4	0.100
P6KE39A	39	37.1	41.0	1.0	33.3	5.0	11.6	53.9	0.100
P6KE43	43	38.7	47.3	1.0	34.8	5.0	10.0	61.9	0.101
P6KE43A	43	40.9	45.2	1.0	36.8	5.0	10.6	59.3	0.101
P6KE47	47	42.3	51.7	1.0	38.1	5.0	9.2	67.8	0.101
P6KE47A	47	44.7	49.4	1.0	40.2	5.0	9.7	64.8	0.101
P6KE51	51	45.9	56.1	1.0	41.3	5.0	8.5	73.5	0.102
P6KE51A	51	48.5	53.6	1.0	43.6	5.0	8.9	70.1	0.102
P6KE56	56	50.4	61.6	1.0	45.4	5.0	7.8	80.5	0.103
P6KE56A	56	53.2	58.8	1.0	47.8	5.0	8.1	77.0	0.103
P6KE62	62	55.8	68.2	1.0	50.2	5.0	7.0	89.0	0.104
P6KE62A	62	58.9	65.1	1.0	53.0	5.0	7.4	85.0	0.104
P6KE68	68	61.2	74.8	1.0	55.1	5.0	6.4	98.0	0.104
P6KE68A	68	64.6	71.4	1.0	58.1	5.0	6.8	92.0	0.104
P6KE75	75	67.5	82.5	1.0	60.7	5.0	5.8	108.0	0.105
P6KE75A	75	71.3	78.8	1.0	64.1	5.0	6.1	103.0	0.105
P6KE82	82	73.8	90.2	1.0	66.4	5.0	5.3	118.0	0.105
P6KE82A	82	77.9	86.1	1.0	70.1	5.0	5.5	113.0	0.105
P6KE91	91	81.9	100.0	1.0	73.7	5.0	4.8	131.0	0.106
P6KE91A	91	86.5	95.5	1.0	77.8	5.0	5.0	125.0	0.106
P6KE100	100	90.0	110.0	1.0	81.0	5.0	4.3	144.0	0.106
P6KE100A	100	95.0	105.0	1.0	85.5	5.0	4.5	137.0	0.106
P6KE110	110	99.0	121.0	1.0	89.2	5.0	3.9	158.0	0.107
P6KE110A	110	105.0	116.0	1.0	94.0	5.0	4.1	152.0	0.107
P6KE120	120	108.0	132.0	1.0	97.2	5.0	3.6	173.0	0.107
P6KE120A	120	114.0	126.0	1.0	102.0	5.0	3.8	165.0	0.107
P6KE130	130	117.0	143.0	1.0	105.0	5.0	3.3	187.0	0.107
P6KE130A	130	124.0	137.0	1.0	111.0	5.0	3.5	179.0	0.107
P6KE150	150	135.0	165.0	1.0	121.0	5.0	2.9	215.0	0.108
P6KE150A	150	143.0	158.0	1.0	128.0	5.0	3.0	207.0	0.108
P6KE160	160	144.0	176.0	1.0	130.0	5.0	2.7	230.0	0.108
P6KE160A	160	152.0	168.0	1.0	136.0	5.0	2.8	219.0	0.108
P6KE170	170	153.0	187.0	1.0	138.0	5.0	2.5	244.0	0.108
P6KE170A	170	162.0	179.0	1.0	145.0	5.0	2.6	234.0	0.108
P6KE180	180	162.0	198.0	1.0	146.0	5.0	2.4	258.0	0.108
P6KE180A	180	171.0	189.0	1.0	154.0	5.0	2.5	246.0	0.108
P6KE200	200	180.0	220.0	1.0	162.0	5.0	2.1	287.0	0.108
P6KE200A	200	190.0	210.0	1.0	171.0	5.0	2.2	274.0	0.108
P6KE220	220	198.0	242.0	1.0	175.0	5.0	1.8	344.0	0.108
P6KE220A	220	209.0	231.0	1.0	185.0	5.0	1.9	328.0	0.108
P6KE250	250	225.0	275.0	1.0	202.0	5.0	1.7	360.0	0.110
P6KE250A	250	237.0	263.0	1.0	214.0	5.0	1.8	344.0	0.110
P6KE300	300	270.0	330.0	1.0	243.0	5.0	1.4	430.0	0.110
P6KE300A	300	285.0	315.0	1.0	256.0	5.0	1.5	414.0	0.110
P6KE350	350	315.0	385.0	1.0	284.0	5.0	1.2	504.0	0.110
P6KE350A	350	332.0	368.0	1.0	300.0	5.0	1.3	482.0	0.110
P6KE400	400	360.0	440.0	1.0	324.0	5.0	1.9	574.0	0.110
P6KE400A	400	380.0	420.0	1.0	342.0	5.0	1.1	548.0	0.110

Notes:  
 1.VBR measured after IT applied for 300us.IT=square wave pulse or equivalent.  
 2.Surge current waveform per Figure 3 and derate per Figure 2.  
 3.For bipolar types having VWMof 10 volts and under,the ID limit is doubled.  
 4.All terms and symbols are consistent with ANSI/IEEE C62.35.